

Varenummer: 03446045
Beskrivelse: Fluro Heavy Duty Ledleje GE 45 GW-2RS
Hul Ø45
Note: 45

Mål

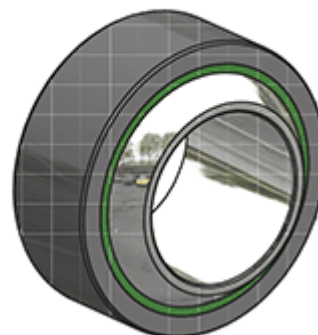
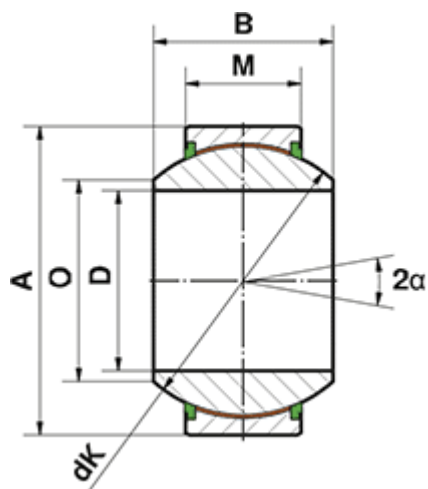

= -	Dynamisk belastning C (kN) = 442
= -	M = 28
= -	O = 50
A = 75	Statisk belastning C0 (kN) = 737
a (grader) = 15	Vægt (g) = 670
B = 43	
D = 45	
dK = 66	